

Open 3-manifolds, wild subsets of S^3 and branched coverings

José María MONTESINOS-AMILIBIA*

Facultad de Matemáticas
Universidad Complutense
28040 Madrid, Spain
montesin@mat.ucm.es

Recibido: 31 de Enero de 2002

Aceptado: 9 de Diciembre de 2002

Dedicated with respect and affection to Professor Laurent Siebenmann

ABSTRACT

In this paper, a representation of closed 3-manifolds as branched coverings of the 3-sphere, proved in [13], and showing a relationship between open 3-manifolds and **wild knots and arcs** will be illustrated by examples. It will be shown that there exist a 3-fold simple covering $p : S^3 \rightarrow S^3$ branched over *the remarkable simple closed curve* of Fox [4] (a wild knot). Moves are defined such that when applied to a branching set, the corresponding covering manifold remains unchanged, while the branching set changes and becomes wild. As a consequence every closed, oriented 3-manifold is represented as a 3-fold covering of S^3 branched over a wild knot, in plenty of different ways, confirming the versatility of irregular branched coverings. Other collection of examples is obtained by pasting the members of an infinite sequence of two-component strongly-invertible link exteriors. These open 3-manifolds are shown to be 2-fold branched coverings of wild knots in the 3-sphere. Two concrete examples, are studied: the *solenoidal manifold*, and the *Whitehead manifold*. Both are 2-fold covering of the euclidean space \mathbf{R}^3 branched over an uncountable collection of string projections in \mathbf{R}^3 .

2000 Mathematics Subject Classification: 57M12, 57M30, 57N10.

Key words: Wild knots, open manifolds, branched coverings

*Supported by BMF-2002-04137-C02-01

1. Introduction

The classical relationship between tame links and closed 3-manifolds has been extremely fruitful in the past. Recently, Hoste [9] has generalized Kirby calculus, based on framed links in S^3 , to deal with open 3-manifolds. In this generalization, the role played by a framed link in S^3 is played by a locally finite disjoint collection of **tame framed knots** living in (S^3 -totally disconnected tame subset). In this paper, however, we have in mind another well known relationship. We allude to the representation of closed 3-manifolds as branched coverings of the 3-sphere. In [13] we have generalized this to open 3-manifolds. In this way we have exhibited a relationship between open 3-manifolds and **wild knots and arcs** in the sphere which is made precise in the following statement, proved in [13]. If \widehat{M} is the Freudenthal compactification of a connected, oriented 3-manifold without boundary M , then there exist a 3-fold simple branched covering $p : \widehat{M} \rightarrow S^3$ such that p maps the end space $E(M)$ of M homeomorphically onto a tame subset T of S^3 . The 3-fold branched covering

$$p \mid M : M \rightarrow S^3 - T$$

is simple, and the branching set is a locally finite disjoint union of properly embedded real lines (or strings).

This paper is devoted to illustrate this, and a related Theorem about 2-fold branched coverings, by means of examples. In section 2 of this paper we will show that there exist a 3-fold simple covering $p : S^3 \rightarrow S^3$ branched over *the remarkable simple closed curve* of Fox [4] (a wild knot). This allows to define a move, such that when applied to a branching set, the corresponding covering manifold remains unchanged, while the branching set changes and becomes wild. This implies that every closed, oriented 3-manifold is a 3-fold covering of S^3 branched over a wild knot. And, in fact, this can be done in plenty of different ways. This confirms the well known flexibility when dealing with irregular branched coverings. This is illustrated with some additional examples.

The theorem about 2-fold branched coverings, mentioned above (also proved in [13]) says that under some conditions, an open, connected, oriented 3-manifold M is a 2-fold branched covering of the 3-sphere minus some 0-dimensional set. In section 3, we illustrate this theorem with examples of open 3-manifolds with one end. A convenient collection of examples is obtained by pasting the members of an infinite sequence of two-component strongly-invertible link exteriors. These open 3-manifolds are 2-fold branched coverings of wild knots in the 3-sphere (minus the wild point). Two concrete examples, and their generalizations, will be studied with special care. They are the complement in S^3 of the solenoidal continuum, and of the Whitehead continuum. The first one will be called here the *solenoidal manifold*, and the second one is the celebrated open, contractible 3-manifold discovered by J.H.C. Whitehead (*Whitehead manifold*). Each one of these manifolds is a 2-fold covering of the euclidean space \mathbf{R}^3 branched over a string. Moreover, there are uncountable

many string projections in \mathbf{R}^3 with this property. It is left as an open problem to show that this set of string projections contains uncountably many *different* strings.

These results were announced in [12].

2. Some mixed preliminaries.

A *knot* in a 3-manifold M is a PL embedding of the 1-dimensional sphere S^1 in M . A *string* in an open 3-manifold M is a PL proper embedding of the real line \mathbf{R}^1 in M . Let T be a compact, totally disconnected subset of S^3 . A *T-tangle* L in S^3 will be a subset of S^3 such that $L - T$ is a locally finite, disjoint union of knots and strings in $S^3 - T$, and every point of T is adherent to $L - T$. Then $L - T$ is called the *tame part of L*. The adherence in S^3 of a string in $S^3 - T$ is either a (*wild*) *arc* or a (*wild*) *knot* in S^3 . We say that a compact, totally disconnected subset T of S^3 is *tamely embedded*, if it lies in a rectilinear segment in $S^3 = \mathbf{R}^3 + \infty$.

Following Fox [3], we say that a space X is *locally connected* in a space Y if there is a basis of Y such that $V \cap X$ is connected for every basic open set V . Freudenthal [5] (see [3]) has shown that every connected, locally connected, locally compact, regular, T_1 space X with a numerable basis, is contained in a compact space Y with the same properties in such a way that X is dense, open and locally connected in Y , and the *end space* $E(X) := Y - X$ is totally disconnected. Moreover, this compactification Y of X (*Freudenthal compactification*) is determined by these properties.

A *represented T-tangle* (L, ω) is a T -tangle L in S^3 together with a transitive representation ω of $\pi_1(S^3 - L)$ into the symmetric group S_n of n indices. The representation is *simple* if it represents meridians by transpositions.

Given a represented T -tangle (L, ω) in S^3 there exist a branched covering (in Fox sense [3])

$$\widehat{p} : \widehat{M}(L, \omega) \rightarrow S^3$$

of n sheets, which is the Fox completion of the spread $j \circ f$, where f is the ordinary covering of $S^3 - L$ with monodromy ω , and

$$j : S^3 - L \rightarrow S^3$$

is the inclusion map. (Note that $j \circ f$ satisfies the conditions listed in [3] granting the existence and unicity of the completion

$$\widehat{p} : \widehat{M}(L, \omega) \rightarrow S^3.)$$

The covering \widehat{p} restricted to

$$\widehat{p}^{-1}(S^3 - T) := M(L, \omega)$$

defines a branched covering

$$p : M(L, \omega) \rightarrow S^3 - T$$

where $M(L, \omega)$ is an open 3-manifold, oriented and connected.

Since p is a finite covering, and S^3 is the Freudenthal compactification of $S^3 - T$, then $\widehat{M}(L, \omega)$ is the Freudenthal compactification of $M(L, \omega)$. This follows from the following direct generalization of the Compactification Theorem of Fox ([3], page 249):

Theorem 1. *Let $f : X \rightarrow B$ be a branched covering. Assume X and B are connected, locally connected, locally compact, with base numerable, T_1 and regular, but no compact. Let \widehat{B} be the Freudenthal compactification of B , and let j be the inclusion $j : B \subset \widehat{B}$. Let $g : Y \rightarrow \widehat{B}$ be the branched covering which is the Fox completion of $j \circ f : X \rightarrow \widehat{B}$. Then, Y is the Freudenthal compactification of X if \widehat{B} has a basis such that, for each basic open set W , the number of components of $f^{-1}(W)$ is finite.*

In general $\widehat{M}(L, \omega)$ is not a manifold at the points belonging to the end space

$$E(M(L, \omega)) := \widehat{M}(L, \omega) - M(L, \omega).$$

Of course, $\widehat{p}(E(M(L, \omega))) = T$. The covering

$$\widehat{p} : \widehat{M}(L, \omega) \rightarrow S^3$$

will be called *simple* if ω is simple.

In [13] the following theorem was proved.

Theorem 2. *The Freudenthal compactification \widehat{M} of a connected, oriented 3-manifold without boundary M is a 3-fold simple covering of S^3 branched over a $E(M)$ -tangle L in S^3 , where the end space $E(M)$ of M is tamely embedded in S^3 . Moreover $L - E(M)$ can be assumed to be a disjoint union of strings.*

This is a generalization of the Theorem of Hilden [6],[7] and the author [10],[11] (independently), because, when M is compact, $\widehat{M} = M$; $E(M)$ is empty, and L is a disjoint union of a finite set of knots (in fact, just one knot is enough).

The proof of the above Theorem uses the following representation of 3-manifolds without boundary given by Hoste [9]. Let Γ be a tree (a contractible locally finite 1-complex). To each vertex v of Γ is associated a compact, connected, oriented 3-manifold X_v . The boundary components of X_v are in one to one correspondence with the edges of Γ with vertex v . To each edge e of Γ we associate an orientation reversing homeomorphism

$$f_e : \Sigma_{v,e} \rightarrow \Sigma_{w,e}$$

between the corresponding boundary components $\Sigma_{v,e}$ of X_v and $\Sigma_{w,e}$ of X_w . The manifold $M(\Gamma)$ is obtained by pasting together the pieces X_v by means of the homeomorphisms f_e .

In [13] the following theorem is proved.

Theorem 3. *Let M be a connected, oriented 3-manifold without boundary which is represented by a tree Γ , to each vertex v of which, is associated a compact, oriented 3-manifold X_v such that (i) BdX_v is composed of n_v connected components of genus ≤ 2 , and (ii) X_v is a 2-fold branched covering of the adherence of S^3 minus n_v disjoint 3-balls. Then \widehat{M} is a 2-fold covering of S^3 branched over a $E(M)$ -tangle L in S^3 , where $E(M)$ is tamely embedded in S^3 .*

Rational link are classified by fractions p/q in lower terms with p even and $0 < q < p$ (see [14]and[1]). This link p/q is *interchangeable*. This means that there exist an orientation preserving homeomorphism of S^3 interchanging the two components v^+ and v^- of p/q . An *ad hoc* description of p/q , useful for our purposes, is the following [8]. Take the (unique) continuous fraction expansion of p/q of the form

$$[2, n_1, -2, n_2, 2, n_3, -2, \dots, n_s, (-1)^s 2],$$

where the numbers $\{n_1, n_2, n_3, \dots, n_s\}$ are integers $\neq 0$. Then the link p/q is depicted in Figure 1. Since the link is interchangeable it is irrelevant what component of p/q is called $+$ or $-$. Note that the components v^+ and v^- of p/q are both trivial knots.

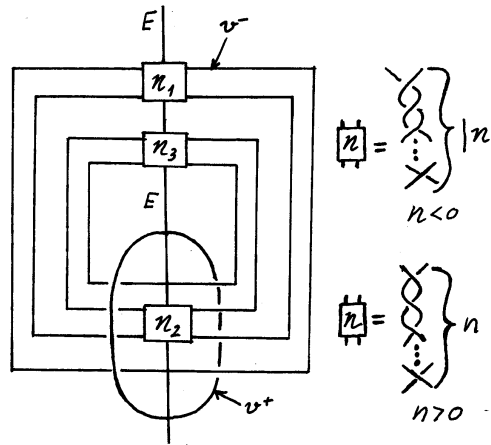

Figure 1: Rational link p/q

We assume S^3 oriented. In pictures, the positive orientation of S^3 will be a right handed screw. Let V^\pm be a regular neighbourhood of v^\pm , such that $V^+ \cap V^- = \emptyset$. Let $X(p/q)$ be the adherence of $S^3 - (V^+ \cup V^-)$. Give to $X(p/q)$ the induced orientation. Thus $X(p/q)$ is a compact, oriented 3-manifold bounded by oriented tori $T^\pm := BdV^\pm$. Take meridian-longitude pairs (M^\pm, L^\pm) in T^\pm in the usual way; that is, M^\pm is a meridian of V^\pm oriented arbitrarily, and L^\pm is parallel to $(p/q)^\pm$, nullhomologous in $S^3 - V^\pm$, and oriented in such a way that the linking number between M^\pm and L^\pm is $+1$ in the oriented S^3 .

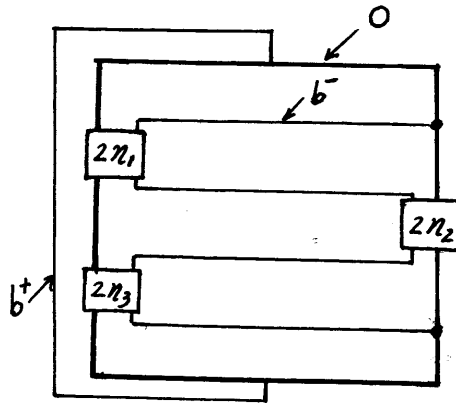

Figure 2: The branching set

Since p/q is strongly invertible, there exist an involution (180° rotation around the E axis) defining a 2-fold covering

$$\widehat{g} : S^3 \rightarrow S^3,$$

branched over the trivial knot O and sending v^\pm onto the arcs b^\pm of Figure 2. By restriction, $\widehat{g} : S^3 \rightarrow S^3$ defines a 2-fold branched covering

$$g : X(p/q) \rightarrow S^2 \times [-1, 1],$$

sending $T^\pm := BdV^\pm$ onto $S^2 \times \{\pm 1\}$. The branching set of $g : X(p/q) \rightarrow S^2 \times [-1, 1]$ will be denoted by $R(p/q)$. It is depicted in Figure 3. The two curves

$$M^\pm \cup L^\pm \cup \widetilde{M}^\pm \cup \widetilde{L}^\pm$$

(each one composed of four arcs) lift to standard meridian-longitude pairs of the trivial knots v^\pm .

3. The remarkable simple closed curve of Fox.

Let (L, ω) be a represented T -tangle in S^3 , where ω is a simple representation of $\pi_1(S^3 - L)$ onto the symmetric group S_3 of the indices $\{1, 2, 3\}$. Thus ω sends meridians of L to transpositions $(1, 2)$, $(1, 3)$, or $(2, 3)$ of S_3 , which, following a beautiful idea of Fox, will be represented by colors Red ($R = (1, 2)$), Green ($G = (1, 3)$) and Blue ($B = (2, 3)$). If the representation exists we can endow each overpass of a normal projection of L with one of the three colors R, G, B in such a way that the colors

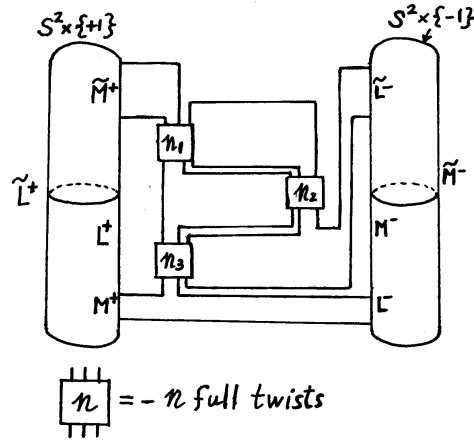

Figure 3: $R(p/q)$

meeting in a crossing are all equal or all are different. Moreover, at least two colors are used. In most cases, (for instance tame or wild knots) these conditions are also sufficient. A tangle with a coloration corresponding to some ω is a *colored T-tangle*. Theorem 2 says that every connected, oriented 3-manifold without boundary is $M(L, \omega)$ for some colored T-tangle (L, ω) .

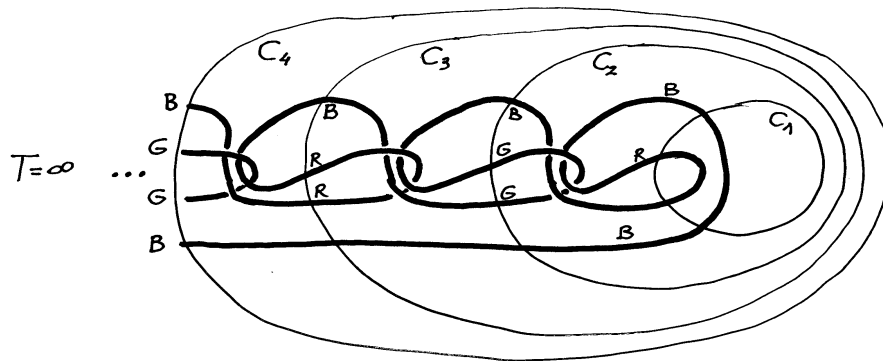

Figure 4: Fox curve

Consider the colored T-tangle (L, ω) of Figure 4, where T consists of just one point. This colored T-tangle was first considered by R. H. Fox in [4]; he considered L a **remarkable simple closed curve**. We will call L **Fox curve**, and we intend to show in this paper that Fox curve is even more remarkable than expected. The colored

T -tangle (L, ω) is a colored wild knot and we will prove the following Theorem.

Theorem 4. *For the colored Fox curve (L, ω) of Figure 1 the space $\widehat{M}(L, \omega)$ is homeomorphic to S^3 . Thus there exist a 3-fold simple covering $\widehat{p}: S^3 \rightarrow S^3$ branched over the Fox curve L .*

Proof. We will give two different proofs.

First Proof. Assume $T = \infty$. Select a sequence of closed 3-balls $\{C_i^3\}_{i=1}^\infty$ such that $C_i^3 \subset \text{Int}(C_{i+1}^3)$ and

$$\cup_{i=1}^\infty C_i^3 = \mathbf{R}^3 = S^3 - \infty,$$

as indicated in Figure 4. Let

$$p: M(L, \omega) \rightarrow S^3 - T$$

be the simple branched covering given by the representation ω . Then, for $i \geq 1$, $p^{-1}(C_i^3)$ is a closed 3-ball B_i^3 . In fact,

$$p|_{p^{-1}(C_i^3)}: p^{-1}(C_i^3) \rightarrow C_i^3$$

is a 3-fold simple covering of the closed 3-ball C_i^3 , branched over two properly embedded arcs; these arcs are embedded exactly as in case $i = 1$ (see Figure 4). Since it follows easily that $p^{-1}(C_1^3)$ is a closed 3-ball B_1^3 , then $p^{-1}(C_i^3)$ is also a closed 3-ball B_i^3 . It is clear that $B_i^3 \subset \text{Int}B_{i+1}^3, i \geq 1$, and that

$$M(L, \omega) = \cup_{i=1}^\infty B_i^3.$$

From this it follows that $M(L, \omega)$ is homeomorphic to \mathbf{R}^3 [2].

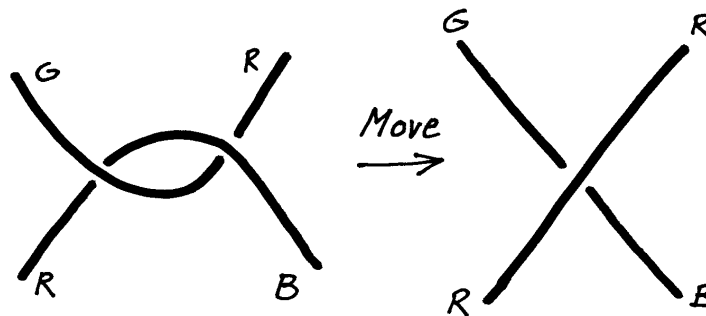

Figure 5: The move

Second Proof. The move of Figure 5, [11], has the following property. *If this move is applied to a portion of a colored T -tangle, we obtain a new colored T -tangle whose*

corresponding 3-fold branched covering spaces are homeomorphic. Thus, apply this move simultaneously to each of the sections of the wild colored knot (L, ω) of Figure 4, as depicted in Figure 6. The colored wild knot (L, ω) is converted in the colored T-tangle (L_1, ω_1) of Figure 7, which is homeomorphic to a bouquet of two circles, whose corresponding 3-fold branched covering space is S^3 . Therefore also $\widehat{M}(L, \omega) = S^3$, as claimed. ■

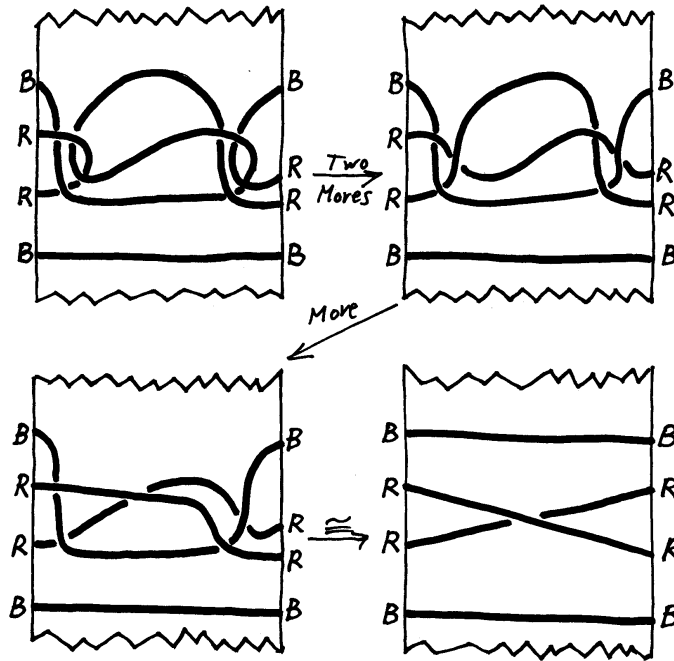

Figure 6: Applying moves

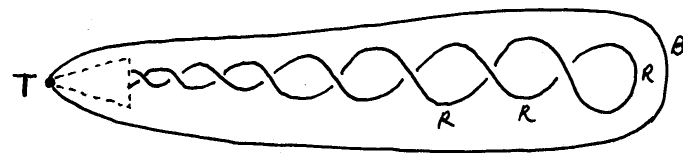

Figure 7: A colored bouquet

Trading what is outside ball C_1^3 of Figure 4, with what is inside it one gets the following Corollary.

Corollary 5. *There is a move of the form indicated in Figure 8, such that when applied to a portion of a colored T_1 -tangle, we obtain a new colored $(T_1 \cup T)$ -tangle whose corresponding 3-fold branched covering spaces are homeomorphic.*

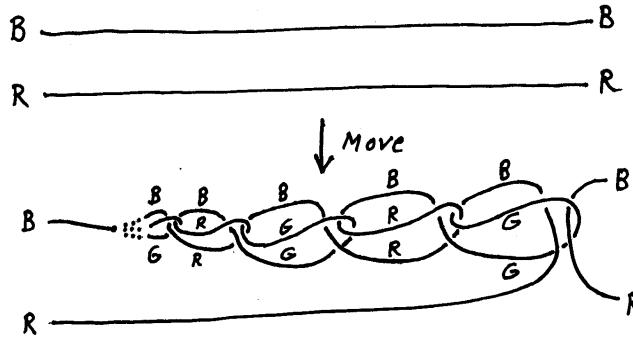

Figure 8: A new move

Remark 6. A wise application of this move can increase the cardinality of the set T from any finite discrete set of S^3 to a point-convergent sequence of points. We inductively create new moves whose defining 3-balls contain T -tangles, where T is any countable, tame, closed, totally disconnected set. This shows that the 3-fold branched coverings $\hat{p} : S^3 \rightarrow S^3$ can have very wild branching sets. The following Corollary implies that the same can be said of any closed, oriented 3-manifold. (In the last section of this paper we will create a non standard 2-fold branched coverings $\hat{p} : S^3 \rightarrow S^3$ with T a Cantor set.)

Corollary 7. *Every closed, oriented 3-manifold is a 3-fold covering of S^3 branched over a colored wild knot.*

Proof. By Theorem 1 the manifold in question is a 3-fold covering of S^3 branched over a colored tame knot. Apply now the move granted by Corollary 4. ■

I conjecture that every closed, oriented 3-manifold is a 3-fold covering of S^3 branched over a colored wild knot in uncountably many different ways. The following construction will construct uncountably many colored wild knot **projections** in S^3 whose associated branched covering space is S^3 . Only (!) remains to show that that collection contains uncountably many different knot types, which seems very likely.

Take the colored T-tangle of Figure 7 and isotope it to the colored T-tangle depicted in Figure 9 (all the isotopies can be done simultaneously), having the property

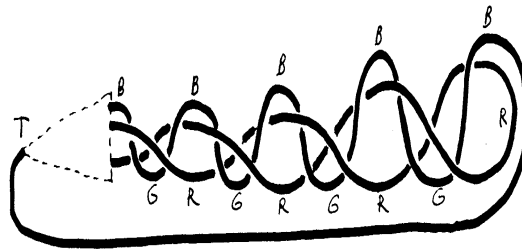

Figure 9: A colored bouquet

that **in each crossing meet three different colors**. Apply now the move of Figure 5 to these infinite crossings in all possible ways. In this way we obtain uncountably many colored wild knot projections in S^3 whose associated branched covering space is S^3 . An example is shown in Figure 10. In this example we have applied the move in a sequence of crossings. The application can be characterized by a sequence like: $\{1, 1, 1, \dots\}$. If the no-application of the move is denoted with the symbol 0, the T-tangle of Figure 9 is denoted by $\{0, 0, 0, \dots\}$. Any sequence of symbols 0 and 1 will define a colored T-tangle whose associated branched covering space is S^3 .

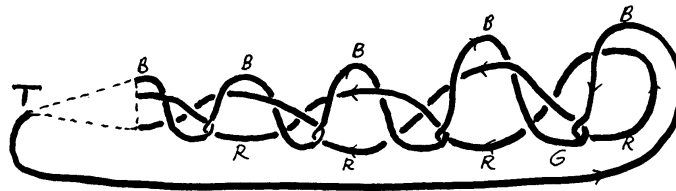

Figure 10: A colored wild knot

Example 8. The colored T-tangle (L, ω) of Figure 11 has $M(L, \omega)$ homeomorphic to the one point compactification of the infinite connected sum of projective 3-spaces

$$\#_{i=1}^{\infty} \mathbf{R}P^3.$$

This is proved using moves, as depicted. (Use the fact that the 2-fold covering of S^3 branched over the rational link $2/1$ is $\mathbf{R}P^3$.)

4. Manifolds with one end and 2-fold coverings.

We start with the simplest non trivial example. Consider the rational link $L = 4/1$ of Figure 12, which is composed of two trivial knots v^+ and v^- (compare with section 2).

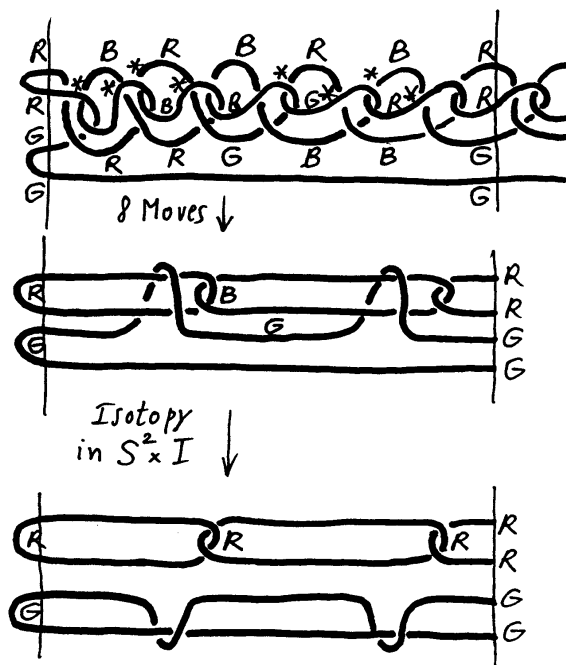

Figure 11

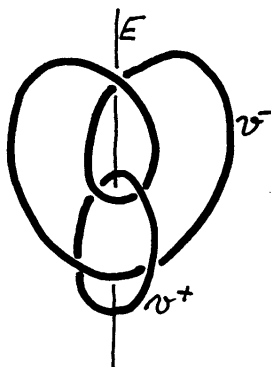

Figure 12: $L = 4/1$

Rotation of 180° around the E-axis defines a 2-fold covering $\hat{g} : S^3 \rightarrow S^3$ branched over the trivial knot $O := \hat{g}(E)$. Take disjoint 3-ball neighbourhoods B^\pm of the arcs

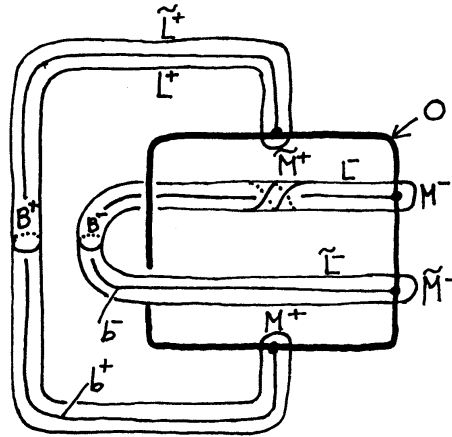

Figure 13

$b^\pm := \widehat{g}(v^\pm)$ as in Figure 13, and consider the two depicted curves

$$M^\pm \cup L^\pm \cup \widetilde{M}^\pm \cup \widetilde{L}^\pm,$$

each one composed of four arcs. Call $V^\pm := \widehat{g}^{-1}(B^\pm)$. This is a solid torus, regular neighbourhood of v^\pm . In the boundary T^\pm of V^\pm take the pairs $\widehat{g}^{-1}(M^\pm, L^\pm)$ and $\widehat{g}^{-1}(\widetilde{M}^\pm, \widetilde{L}^\pm)$. These are standard meridian-longitude pairs of the trivial knots v^\pm . Orient them so that their linking number in S^3 be +1. Since there is no risk of confusion, we will denote $\widehat{g}^{-1}(M^\pm, L^\pm)$ by the symbol (M^\pm, L^\pm) . (Analogously with $\widehat{g}^{-1}(\widetilde{M}^\pm, \widetilde{L}^\pm)$; see Figure 14.)

We will define three open, connected, oriented 3-manifolds S_1, S_2, S_3 with one end.

The solenoidal manifold S_1 . Call $X = X(4/1)$ the exterior

$$S^3 - \text{Int}(V^+ \cup V^-)$$

of the link L . Take a sequence $\{X_i\}_{i=1}^\infty$ of copies of X , and a solid torus X_0 with meridian M_0^- . Paste X_0 with X_1 in such a way that M_0^- is identified with M_1^+ . Paste X_i with X_{i+1} along the boundaries T_i^- and T_{i+1}^+ in such a way that the pair (M_i^-, L_i^-) is identified with the pair (L_{i+1}^+, M_{i+1}^+) . This defines the manifold S_1 . We will call S_1 the *solenoidal manifold*. It enjoys the following two properties:

Property 1. $X_0 \cup X_1 \cup \dots \cup X_n$ is a solid torus, for each $n \geq 0$.

Property 2. S_1 can be embedded in S^3 (in such a way that its complement is the celebrated solenoidal continuum).

We will presently find uncountably many strings in \mathbf{R}^3 with the same 2-fold branched covering S_1 .

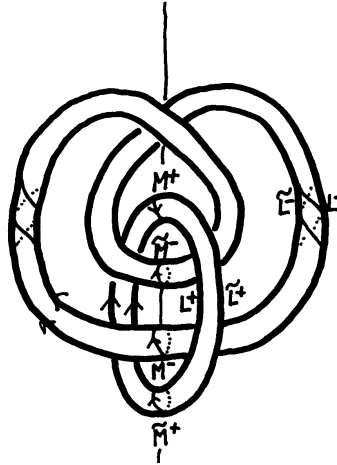

Figure 14: $X(4/1)$

The manifold X is (by restriction of $\widehat{g}: S^3 \rightarrow S^3$) a 2-fold branched covering

$$g: X \rightarrow S^2 \times [-1, 1],$$

where $S^3 - \text{Int}(B^+ \cup B^-)$ is identified with $S^2 \times [-1, 1]$. The branching set $R = R(4/1)$ is depicted in Figure 15a (compare with Figure 13). The manifold X_0 is a 2-fold branched covering of the ball depicted in Figure 15b; the branching set is called R_0 .

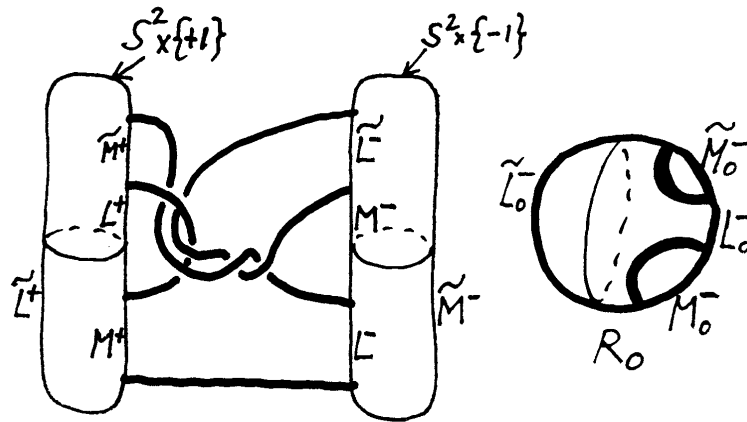

Figure 15: $R = R(4/1)$

Notice the symmetry enjoyed by R and exhibited in Figure 16. This involutory

symmetry is the projection by g of the interchanging symmetry common to all rational links.

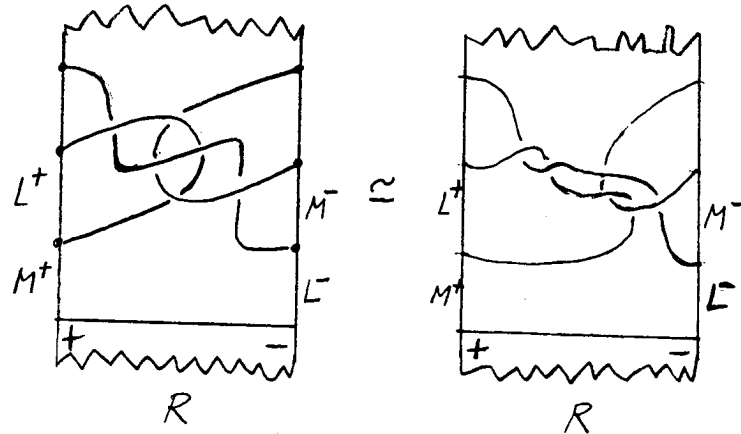

Figure 16: R

Take now a sequence $\{R_i\}_{i=1}^\infty$ of copies of R , and paste R_0 with R_1 in such a way that (M_0^-, L_0^-) is identified with (M_1^+, L_1^+) . Paste R_i with R_{i+1} in such a way that the pair (M_i^-, L_i^-) is identified with the pair (L_{i+1}^+, M_{i+1}^+) . This defines a string in \mathbf{R}^3 , denoted by $R_0 R R R \dots$, and shown in Figure 17.

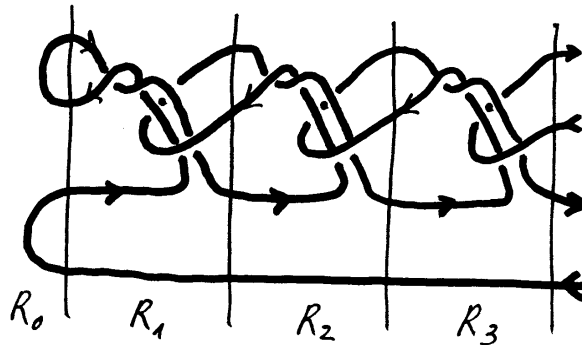

Figure 17: The wild knot $R_0 R R R \dots$

It immediately follows that *the solenoidal manifold is the 2-fold covering of \mathbf{R}^3 branched over the string $R_0 R R R \dots$*

To find uncountably many such strings with the same property we make the fol-

lowing observation. Consider the standard 2-fold covering $p : T \rightarrow S$ branched over $P \subset S$, where T, S, P are, respectively, the 2-torus, the 2-sphere, and a set of four points in S . Then, the subgroup of the mapping class group of (S, P) represented by elements lifting to homeomorphisms of T isotopic to identity is the Klein group of four elements

$$\{A_0, A_1, A_2, A_3\},$$

where A_0 is the identity. Three 4-braids realizing the non trivial elements A_1, A_2, A_3 are shown in Figure 18.

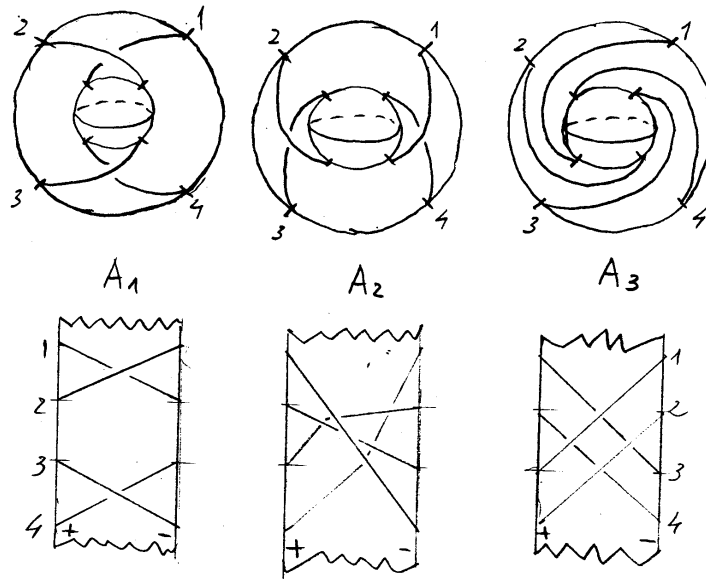

Figure 18

Then, for any map

$$\epsilon : \mathbf{N} \rightarrow \{0, 1, 2, 3\},$$

where \mathbf{N} is the set of integers ≥ 1 , we define the string

$$R_\epsilon := R_0 R A_{\epsilon(1)} R A_{\epsilon(2)} R A_{\epsilon(3)} R \dots$$

in \mathbf{R}^3 . (In Figure 19 we have depicted R_ϵ , for ϵ constantly equal to 2.) Then we

have: *The solenoidal manifold is the 2-fold covering of \mathbf{R}^3 branched over the string R_ϵ , for any map $\epsilon : \mathbf{N} \rightarrow \{0, 1, 2, 3\}$.*

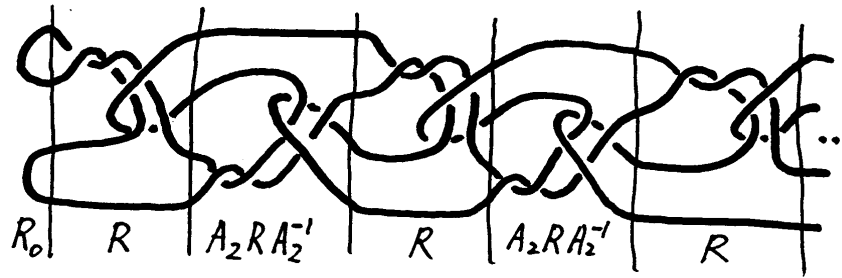

Figure 19: The wild knot $R_0RA_2RA_2RA_2\dots$

Remark 9. I conjecture that the uncountably many wild knot projections R_ϵ contain uncountably many wild knot types.

Remark 10. The wild knots $R_\epsilon + \infty \subset \mathbf{R}^3 + \infty \subset S$, for any ϵ , are almost unknotted in Fox sense [4]. This reflects **Property 1** of S_1 above.

The manifold S_2 . Same definition as S_1 , but instead of identifying (M_i^-, L_i^-) with the pair (L_{i+1}^+, M_{i+1}^+) , identify it with $(\widehat{L}_{i+1}^+, M_{i+1}^+)$, where \widehat{L}_{i+1}^+ is homologous to $M_{i+1}^+ + 2L_{i+1}^+$ on T_{i+1}^+ . Depict again $R = R(4/1)$, enhancing the new curve $\widehat{L}^+ = M^+ + 2L^+$, as in Figure 20.

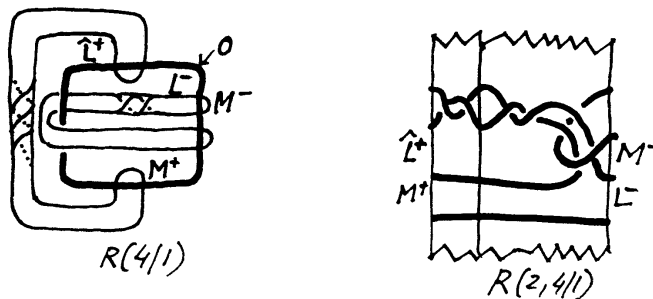

Figure 20

The branching set (with coordinates (M^-, L^-) , (M^+, \widehat{L}^+)) will be denoted by $R(2, 4/1)$. Then, for any $\epsilon : \mathbf{N} \rightarrow \{0, 1, 2, 3\}$ we have the string

$$R(2, 4/1)_\epsilon := R_0R(2, 4/1)A_{\epsilon(1)}R(2, 4/1)A_{\epsilon(2)}R(2, 4/1)A_{\epsilon(3)}R(2, 4/1)\dots$$

in \mathbf{R}^3 . (For instance, in Figure 21 we have depicted

$$R_0R(2, 4/1)R(2, 4/1)R(2, 4/1)R(2, 4/1)\dots,$$

which is Fox curve!)

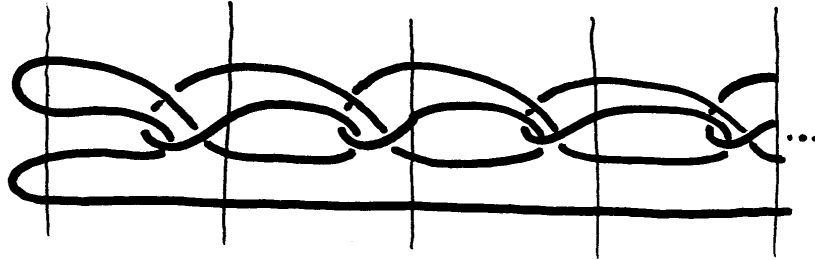

Figure 21: Fox curve

Then we have: *The manifold S_2 is the 2-fold covering of \mathbf{R}^3 branched over the string $R(2, 4/1)_\epsilon$, for any map $\epsilon : N \rightarrow \{0, 1, 2, 3\}$. In particular, the 2-fold covering of S^3 branched over Fox curve is the one point compactification \widehat{S}_2 of the manifold S_2 .*

Remark 11. Again, I conjecture that the uncountably many wild knot projections $R(2, 4/1)_\epsilon$ contain uncountably many wild knot types. As above, all branching sets $R(2, 4/1)_\epsilon + \infty$ are almost unknotted wild knots. This reflects the fact that S_2 has also **Property 1**. However, I do not know if it has **Property 2**, but I conjecture in the negative. Note also that all these wild knots are colorable and that in all cases the corresponding covering manifold is S^3 . Since \widehat{S}_2 is the 2-fold covering of S^3 branched over Fox curve, and S^3 is a 3-fold simple covering of S^3 branched over Fox curve, it follows that there exist a common 6-fold regular dihedral covering N of S^3 , branched over Fox curve. It is an interesting exercise to describe N .

The manifold S_3 . Here (M_i^-, \widehat{L}_i^-) is identified with the pair (L_{i+1}^+, M_{i+1}^+) , where \widehat{L}_i^- is homologous to $M_i^- + 2L_i^-$ on T_i^- . Then $R = R(4/1)$, with new coordinates (M^-, \widehat{L}^-) , (M^+, L^+) , will be denoted by $R(4/1, 2)$ (see Figure 22, which is like Figure 20b but turned around 180°). Then, for any $\epsilon : \mathbf{N} \rightarrow \{0, 1, 2, 3\}$ we define the string

$$R_0 R(4/1, 2) A_{\epsilon(1)} R(4/1, 2) A_{\epsilon(2)} R(4/1, 2) A_{\epsilon(3)} R(4/1, 2) \dots$$

in \mathbf{R}^3 , denoted by $R(4/1, 2)_\epsilon$. (For instance, in Figure 23 we have depicted $R(4/1, 2)_\epsilon$,

for ϵ constantly equal to 0.) Then we have: *The manifold S_3 is the 2-fold covering of \mathbf{R}^3 branched over the string $R(4/1, 2)_\epsilon$, for any map $\epsilon : \mathbf{N} \rightarrow \{0, 1, 2, 3\}$.*

Remark 12. The manifold S_3 satisfies **Property 2** above (embeddable in S^3). However, I am almost sure that none of the wild knots $R(4/1, 2)_\epsilon + \infty$ is almost unknotted. An indication is the following. The knot of Figure 23 is colorable and

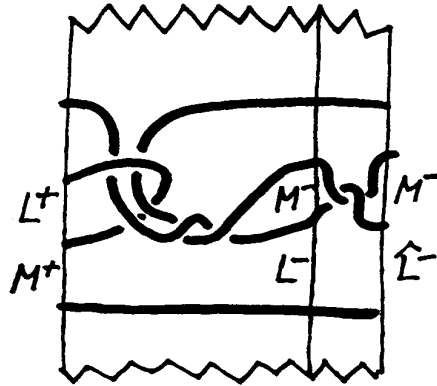

Figure 22: $R(4/1, 2)$

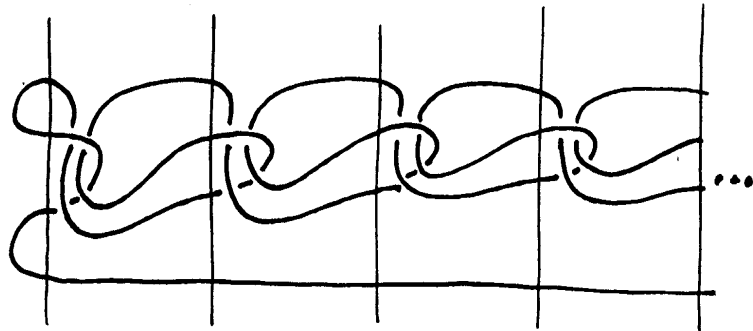

Figure 23

is associated 3-fold branched covering space is the one point compactification of the infinite connected sum of projective 3-spaces (see Example 9 above).

If instead of the space $X = X(4/1)$ we take the exterior $X(p/q)$ of any rational link we can perform the above construction in a more general way. Take an arbitrary sequence $\{(p_i/q_i, m_i)\}_{i=1}^{\infty}$, where p_i/q_i represents a rational link, and m_i is an integer. For $n \geq 1$, let X_n be $X(p_n/q_n)$, the exterior of p_n/q_n ; and let X_0 be a solid torus with meridian M_0^-

Construction 1. Paste X_0 with X_1 in such a way that M_0^- is identified with M_1^+ . Paste X_i with X_{i+1} along the boundaries T_i^- and T_{i+1}^+ in such a way that

the pair (M_i^-, L_i^-) is identified with the pair (L_{i+1}^+, M_{i+1}^+) . This defines the manifold $M\{(p_i/q_i)\}_{i=1}^\infty$. (The typical examples are S_1 , the *solenoidal manifold*, studied above, and $W = M\{(8/3)\}_{i=1}^\infty$, the Whitehead contractible open 3-manifold.) The manifolds $M\{(p_i/q_i)\}_{i=1}^\infty$ enjoy properties 1 and 2 above, i.e.:

Property 1. $X_0 \cup X_1 \cup \dots \cup X_n$ is a solid torus, for each $n \geq 0$.

Property 2. $M\{(p_i/q_i)\}_{i=1}^\infty$ can be embedded in S^3 (the complement of W in S^3 is the celebrated Whitehead continuum).

The branching set $R_i = R(p_i/q_i)$ is depicted in Figure 3. Take now the sequence $\{R_i\}_{i=1}^\infty$ and any map $\epsilon : \mathbf{N} \rightarrow \{0, 1, 2, 3\}$, where \mathbf{N} is the set of integers ≥ 1 . Define the string

$$R_0 R_1 A_{\epsilon(1)} R_2 A_{\epsilon(2)} R_2 A_{\epsilon(3)} R_3 \dots$$

in \mathbf{R}^3 , denoted by $R_\epsilon\{(p_i/q_i)\}_{i=1}^\infty$. (In Figure 24a, and resp. 24b, we have depicted $R_\epsilon\{(8/3)\}_{i=1}^\infty$, for ϵ constantly equal to 0, and resp. 2.) We have the Theorem:

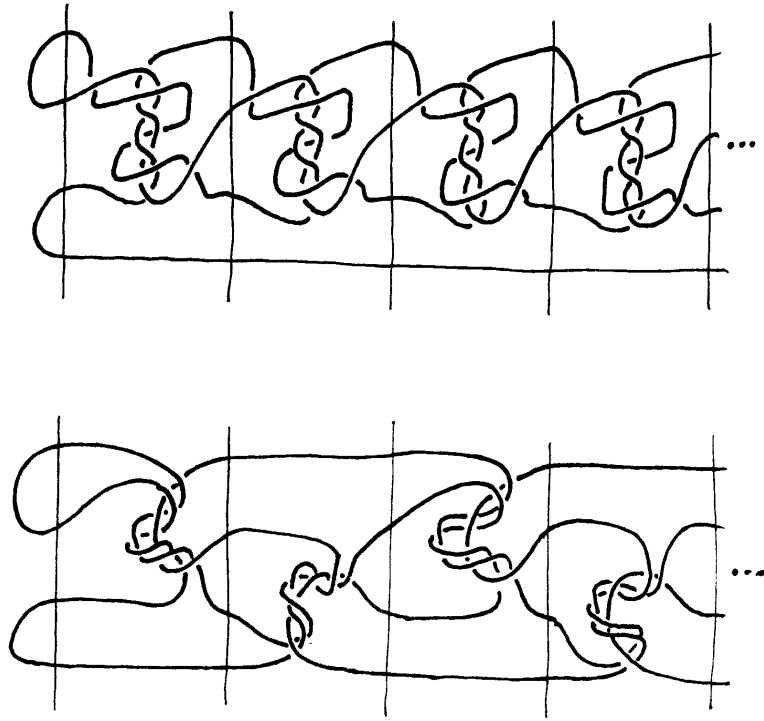

Figure 24: $R_\epsilon\{(8/3)\}_{i=1}^\infty$, $\epsilon = 0, 2$

Theorem 13. *The manifold $M\{(p_i/q_i)\}_{i=1}^\infty$ is the 2-fold covering of \mathbf{R}^3 branched over the string $R_\epsilon\{(p_i/q_i)\}_{i=1}^\infty$, for any map $\epsilon : \mathbf{N} \rightarrow \{0, 1, 2, 3\}$. In particular, the open contractible Whitehead manifold*

$$W = M\{(8/3)\}_{i=1}^\infty$$

is a 2-fold branched covering space of $S^3 - \infty = \mathbf{R}^3$. The branching set is any member of the uncountable family $R_\epsilon\{(8/3)\}_{i=1}^\infty$. In particular \widehat{W} is the 2-fold covering of S^3 branched over the wild knots of Figure 24.

Conjecture 14. *The family $R_\epsilon\{(8/3)\}_{i=1}^\infty$ contains uncountably many different wild knots, so that W contains uncountably many different involution with \mathbf{R}^3 as base space.*

Construction 2. Paste X_0 with X_1 in such a way that M_0^- is identified with M_1^+ . Paste X_i with X_{i+1} along the boundaries T_i^- and T_{i+1}^+ in such a way that the pair (M_i^-, L_i^-) is identified with the pair $(\widehat{L}_{i+1}^+, M_{i+1}^+)$, where \widehat{L}_{i+1}^+ is homologous to $M_{i+1}^+ + m_{i+1}L_{i+1}^+$ on T_{i+1}^+ . This defines the manifold

$$M\{(m_i, p_i/q_i)\}_{i=1}^\infty.$$

(The typical example is $S_2 = M\{(2, 4/1)\}_{i=1}^\infty$ studied above. Another example is $W_4 := M\{(4, 8/3)\}_{i=1}^\infty$.) The manifolds

$$M\{(m_i, p_i/q_i)\}_{i=1}^\infty$$

have **Property 1**, and I expect they do not have **Property 2**. Some of them are contractible open 3-manifolds according to the following generalization of Whitehead example [15]. (If in a rational link p/q the linking number of its two components is zero we say that p/q is a *linking-zero rational link*.)

Theorem 15. *If a cofinal subsequence of $\{(p_i/q_i)\}_{i=1}^\infty$ is formed of linking-zero rational links then the manifold*

$$M\{(m_i, p_i/q_i)\}_{i=1}^\infty$$

is contractible.

Proof. Any compact set K will lie in a solid torus $X_0 \cup X_1 \cup \dots \cup X_{i-1}$ such that the link p_i/q_i is a linking-zero rational link. Note that $X_0 \cup X_1 \cup \dots \cup X_{i-1}$ is V_i^+ . But V_i^+ is contractible in $S^3 - V_i^-$, because v_i^+ is nullhomologous in the solid torus $S^3 - V_i^-$. Thus K is contractible in

$$X_0 \cup X_1 \cup \dots \cup X_i = S^3 - V_i^-.$$

Since K might be any singular sphere we deduce that $M\{(m_i, p_i/q_i)\}_{i=1}^\infty$ is contractible. ■

The branching set $R_i = R(p_i/q_i)$ (with coordinates (M_i^-, L_i^-) , $(M_i^+, \widehat{L}_i^+ = M_i^+ + m_i L_i^+)$) will be denoted by $R(m_i, p_i/q_i)$. Given any map $\epsilon : \mathbf{N} \rightarrow \{0, 1, 2, 3\}$, where \mathbf{N} is the set of integers ≥ 1 , define the string

$$R_0 R(m_1, p_1/q_1) A_{\epsilon(1)} R(m_2, p_2/q_2) A_{\epsilon(2)} R(m_3, p_3/q_3) A_{\epsilon(3)} R(m_4, p_4/q_4) \dots$$

in \mathbf{R}^3 , denoted by $R_\epsilon \{(m_i, p_i/q_i)\}_{i=1}^\infty$. (In Figure 25a, and resp. 25b, we have depicted $R_\epsilon \{(4, 8/3)\}_{i=1}^\infty$, for ϵ constantly equal to 0, and resp. to 2). Then we have:

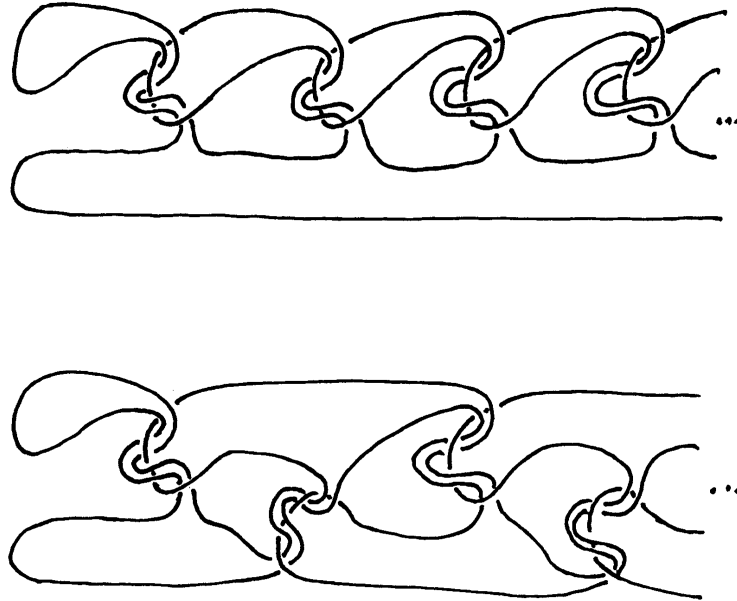

Figure 25: $R_\epsilon \{(4, 8/3)\}_{i=1}^\infty$, for $\epsilon = 0, 2$

Theorem 16. *The manifold $M\{(m_i, p_i/q_i)\}_{i=1}^\infty$ is the 2-fold covering of \mathbf{R}^3 branched over the string $R_\epsilon \{(m_i, p_i/q_i)\}_{i=1}^\infty$, for any map $\epsilon : \mathbf{N} \rightarrow \{0, 1, 2, 3\}$. In particular, the open contractible manifold $W_4 = M\{(4, 8/3)\}_{i=1}^\infty$ is a 2-fold branched covering space of $S^3 - \infty = \mathbf{R}^3$. The branching set is any member of the uncountable family $R_\epsilon \{(4, 8/3)\}_{i=1}^\infty$. In particular \widehat{W}_4 is the 2-fold covering of S^3 branched over the wild knots of Figure 25.*

Remark 17. The wild knots

$$R_\epsilon \{(m_i, p_i/q_i)\}_{i=1}^\infty + \infty \subset \mathbf{R}^3 + \infty \subset S,$$

for any ϵ , are almost unknotted in Fox sense [4]. This reflects **Property 1** of $M\{(m_i, p_i/q_i)\}_{i=1}^\infty$ above.

Construction 3. Paste X_0 with X_1 in such a way that M_0^- is identified with M_1^+ . Paste X_i with X_{i+1} along the boundaries T_i^- and T_{i+1}^+ in such a way that the pair (M_i^-, \widehat{L}_i^-) is identified with the pair (L_{i+1}^+, M_{i+1}^+) , where \widehat{L}_i^- is homologous to $M_i^- + m_i L_i^-$ on T_i^- . This defines the manifold

$$M\{(p_i/q_i, m_i)\}_{i=1}^\infty.$$

(The typical example is $S_3 = M\{(4/1, 2)\}_{i=1}^\infty$ studied above. Another example is $V_4 = M\{(8/3, 4)\}_{i=1}^\infty$.) The manifolds

$$M\{(p_i/q_i, m_i)\}_{i=1}^\infty$$

have **Property 2**. The branching set $R_i = R(p_i/q_i)$ with coordinates (M_i^-, \widehat{L}_i^-) , (L_i^+, M_i^+) will be denoted by $R(p_i/q_i, m_i)$. Given any map $\epsilon : \mathbf{N} \rightarrow \{0, 1, 2, 3\}$, where \mathbf{N} is the set of integers ≥ 1 , define the string

$$R_0 R(p_1/q_1, m_1) A_{\epsilon(1)} R(p_2/q_2, m_2) A_{\epsilon(2)} R(p_3/q_3, m_3) A_{\epsilon(3)} R(p_4/q_4, m_4) \dots$$

in \mathbf{R}^3 , denoted by $R_\epsilon\{(p_i/q_i, m_i)\}_{i=1}^\infty$. (In Figure 26a, and resp. 26b, we have depicted $R_\epsilon\{(8/3, 4)\}_{i=1}^\infty$, for ϵ constantly equal to 0, and resp. 2.) Then, as before, we have:

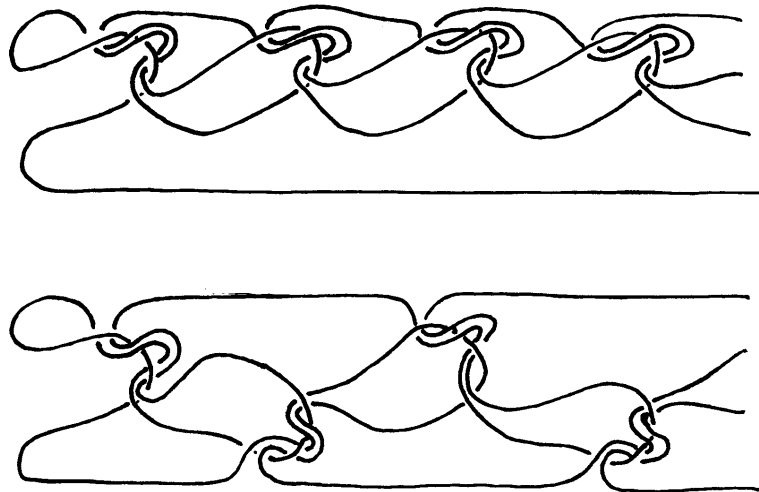

Figure 26: $R_\epsilon\{(8/3, 4)\}_{i=1}^\infty, \epsilon = 0, 2$

Theorem 18. *The manifold $M\{(p_i/q_i, m_i)\}_{i=1}^{\infty}$ is the 2-fold covering of \mathbf{R}^3 branched over the string $R_\epsilon\{(p_i/q_i, m_i)\}_{i=1}^{\infty}$, for any map $\epsilon : \mathbf{N} \rightarrow \{0, 1, 2, 3\}$. In particular, the manifold $V_4 = M\{(8/3, 4)\}_{i=1}^{\infty}$ is a 2-fold branched covering space of $S^3 - \infty = R^3$. The branching set is any member of the uncountable family $R_\epsilon\{(8/3, 4)\}_{i=1}^{\infty}$. In particular \widehat{V}_4 is the 2-fold covering of S^3 branched over the wild knots of Figure 26.*

References

- [1] Burde, Gerhard; Zieschang, Heiner. Knots. De Gruyter Studies in Mathematics, 5. Berlin - New York: Walter de Gruyter. XII, 399 p. (1985).
- [2] Brown, Morton. The monotone union of open n-cells is an open n-cell. Proc. Amer. Math. Soc. 12 (1961) 812–814.
- [3] Fox, Ralph H. Covering spaces with singularities. 1957 A symposium in honor of S. Lefschetz pp. 243–257 Princeton University Press, Princeton, N.J.
- [4] Fox, Ralph H. A remarkable simple closed curve. Ann. of Math. (2) 50, (1949). 264–265.
- [5] Freudenthal, Hans. Über die Enden diskreter Räume und Gruppen. Comment. Math. Helv. 17 (1945) 1–38.
- [6] Hilden, Hugh M. Every closed orientable 3-manifold is a 2-fold branched covering space of S^3 . Bull. Amer. Math. Soc. 80 (1974) 1243–1244.
- [7] Hilden, Hugh M. Three-fold branched coverings of S^3 . Amer. J. Math. 98 (1976), no. 4, 989–997.
- [8] Hilden, Hugh M.; Lozano, María Teresa; Montesinos-Amilibia, José María. On the character variety of periodic knots and links. Math. Proc. Camb. Philos. Soc. 129, No.3, 477-490 (2000).
- [9] Hoste, Jim Framed link diagrams of open 3-manifolds. KNOTS '96 (Tokyo), 515–537, World Sci. Publishing, River Edge, NJ, 1997.
- [10] Montesinos-Amilibia, José María. A representation of closed orientable 3-manifolds as 3-fold branched coverings of S^3 . Bull. Amer. Math. Soc. 80 (1974) 845–846.
- [11] Montesinos-Amilibia, José María. Three-manifolds as 3-fold branched covers of S^3 . Quart. J. Math. Oxford Ser. (2) 27 (1976), no. 105, 85–94.
- [12] Montesinos-Amilibia, José María. Open 3-manifolds as 3-fold branched coverings. Rev.R.Acad.Cien.SerieA.Mat. 95(2001)1-3.
- [13] Montesinos-Amilibia, José María. Representing open 3-manifolds as 3-fold branched coverings, Revista Matemática Complutense, 15 (2002) 533-542.
- [14] Schubert, Horst Knoten mit zwei Brücken. Math. Z. 65, 133-170 (1956).
- [15] Whitehead, J.H.C A certain region in Euclidean 3-space. Proc. Natl. Acad. Sci. USA 21, 364-366 (1935).